

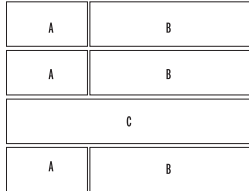

RÖCKA

DESCRIPTION: Wall & edge double-sided **TEXTURE:** Natural stone (Fossil stone)

PALLET OVERVIEW - ROW 1



PALLET OVERVIEW - ROW 2

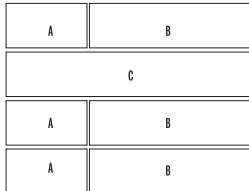

PALLET OVERVIEW - ROW 3

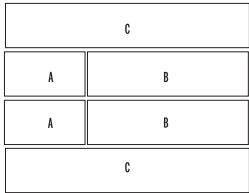

NOTES

*For an authentic look, each color option is composed of a variety of darker & lighter tones. Natural ingredients such as granite are present within the recipe to allow for a range in tones, veining and textures from one stone to another.

See page 135 to 156 for more technical information.

The dimensional tolerance for Stonedge wet cast retaining wall units is: $\pm \frac{3}{16}$ " (5 mm) for height and $\pm \frac{1}{2}$ " (13 mm) for length and width. During the installation, the level between adjacent wall units will vary (usually more than for a dry cast wall unit) in order to obtain a more realistic appearance of a natural stone wall.

Specifications per pallet	Imperial	Metric
Cubing	19.88 ft²	1.85 m ²
Approx. Weight	1 860 lbs	844 kg
Number of rows	3	
Coverage per row	6.63 ft ²	0.62 m ²
Coverage per unit	A	0.55 ft ²
	B	1.10 ft ²
	B	1.66 ft ²

	Unit dimensions	in	mm	Units/pallet
A	Height	6	152	8 units
	Depth 1	7 ³ / ₄	197	
	Depth 2	8	203	
	Length	13 ¹ / ₄	337	
B	Height	6	152	8 units
	Depth 1	7 ³ / ₄	197	
	Depth 2	8	203	
	Length	26 ¹ / ₂	673	
C	Height	6	152	4 units
	Depth 1	7 ³ / ₄	197	
	Depth 2	8	203	
	Length	39 ³ / ₄	1 010	

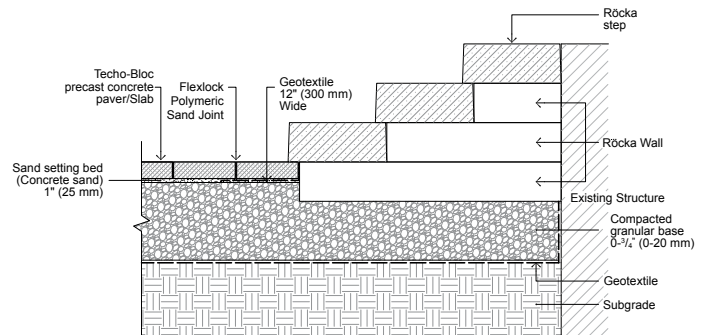

Chocolate Brown Rock Garden Brown Riviera



INSTALLATION GUIDE

FREESTANDING WALLS - RÖCKA

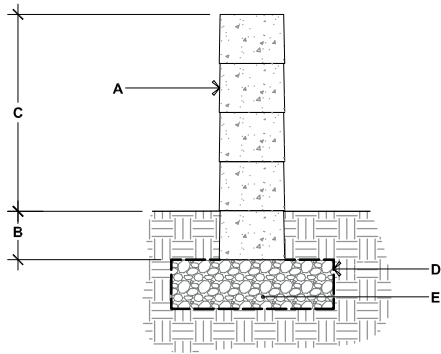

RÖCKA

- A.** RÖCKA DOUBLE-SIDED WALL UNITS SECURE EACH ROW WITH FLEXLOCK ADHESIVE
- B.** EMBEDMENT DEPTH, 6" (150 mm) MIN.
- C.** 24" (612 mm) MAX.
- D.** GEOTEXTILE
- E.** COMPACTED GRANULAR LEVELING PAD, 6" (150 mm) THICK MIN. THICKNESS ACCORDING TO PROJECT SPECIFIC CONDITIONS

90° CORNER OF A DOUBLE-SIDED WALL

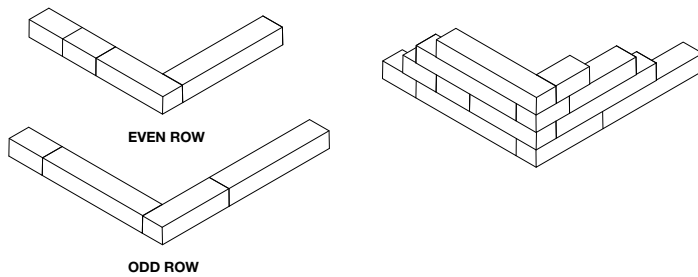

1. Alternate odd and even rows
2. Stagger vertical joints by at least $\frac{1}{4}$ of the length of the block.
3. Glue all modules at each row with Flexlock adhesive.
4. It is possible to alternate the blocks (A, B or C) in the same row to create different patterns.

DOUBLE-SIDED WALL - END OF A STRAIGHT WALL

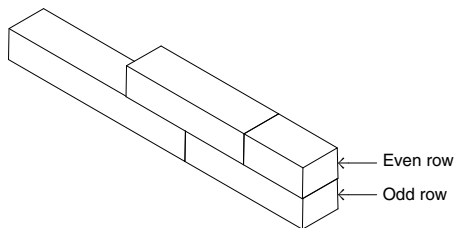

* It is possible to alternate the blocks (A, B or C) in the same row to create different patterns. However, a minimum distance of $\frac{1}{4}$ the length of the block is required between the vertical joints.

INSTALLATION GUIDE

GRILL ISLAND - RÖCKA

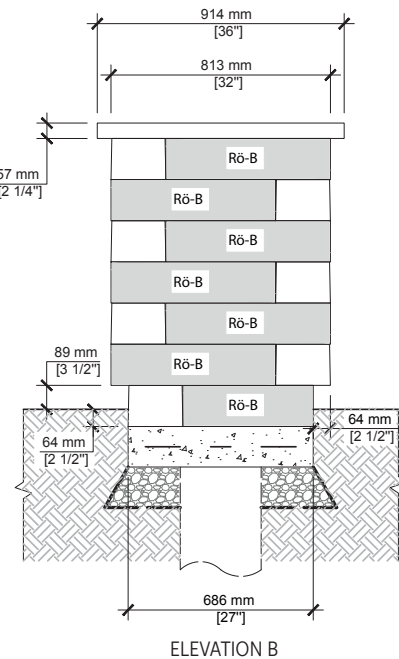
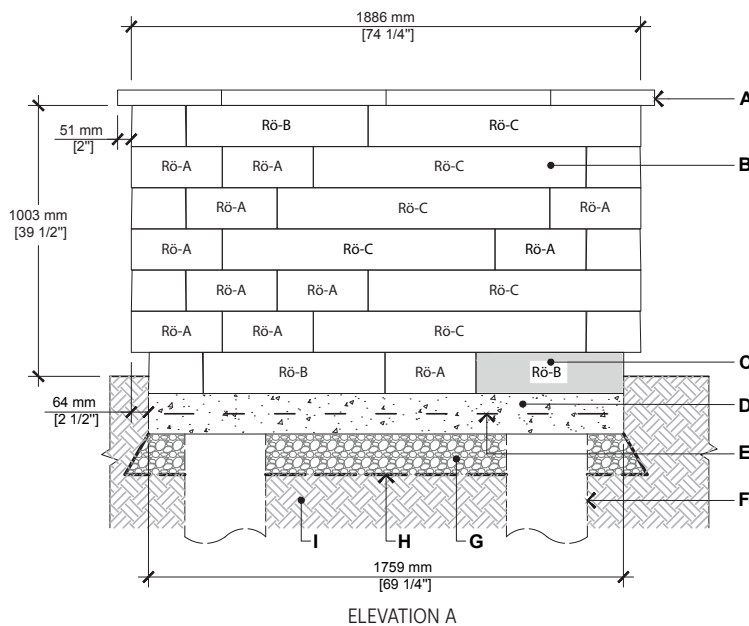
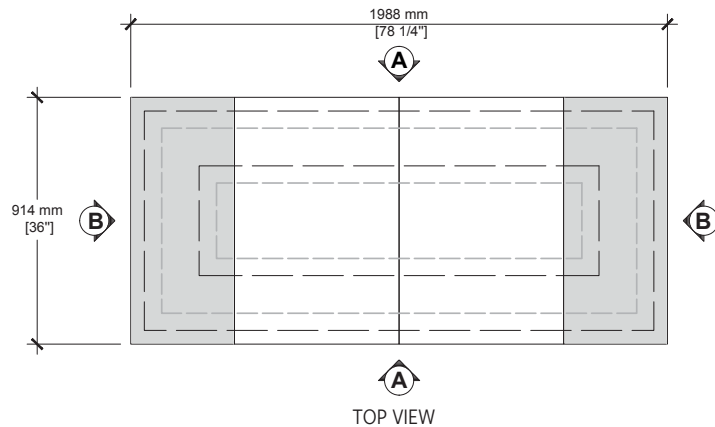

- A.** YORK COUNTER TOP 24" X 36" X 2 1/4" (CUT ON FIELD AS REQUIRED)
- B.** RÖCKA WALL UNIT (A, B OR C)
- C.** RÖCKA WALL UNIT CUT ON FIELD AS REQUIRED
- D.** CAST IN PLACE CONCRETE SLAB 4350 psi (30 MPa), 5" (125 mm) THICK
- E.** 4X4-4/4 (102X102-MW25.8XMW25.8) WELDED WIRE MESH AND/OR REBAR AS PER SITE CONDITIONS
- F.** 12" (300 mm) DIA. CONCRETE PILLAR, AS PER LOCAL CODE
- G.** 3/4" (20 mm) CLEAN STONE
6" (150 mm) THICK MIN. AS PER SITE CONDITIONS
- H.** GEOTEXTILE
- I.** NATURAL SOIL OR COMPACTED BACKFILL

QUANTITY OF MATERIALS REQUIRED

- York Counter top 24" x 36" x 2 1/4": **4**
- Röcka wall unit: **22 A, 20 B, 12 C**

NOTE: Appliances and utilities may vary for each project and are not shown on this drawing. This drawing is shown for inspiration only and surplus or shortage of materials may result. It is the user's responsibility to verify for the quantity of materials required. Secure the blocks using a heat resistant concrete adhesive. The installer must ensure that the installation and use of the grill island comply with local regulations and code requirements. Concrete pillars extending to frost line may be required as per local code. Check your local building code before installing.